

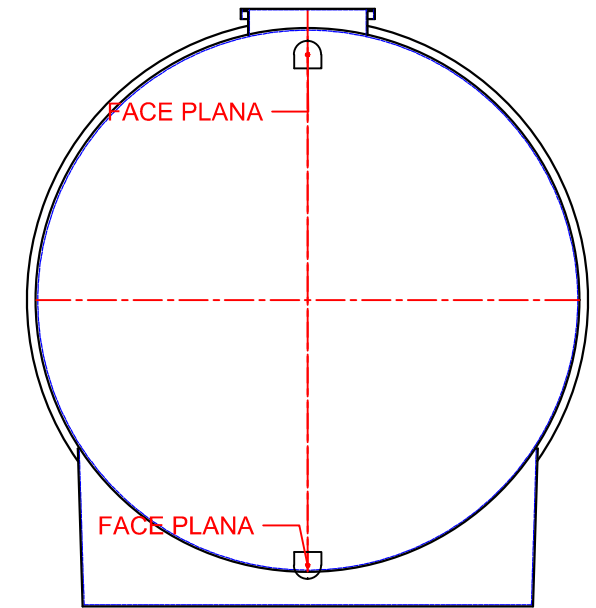

TANQUE 45M3

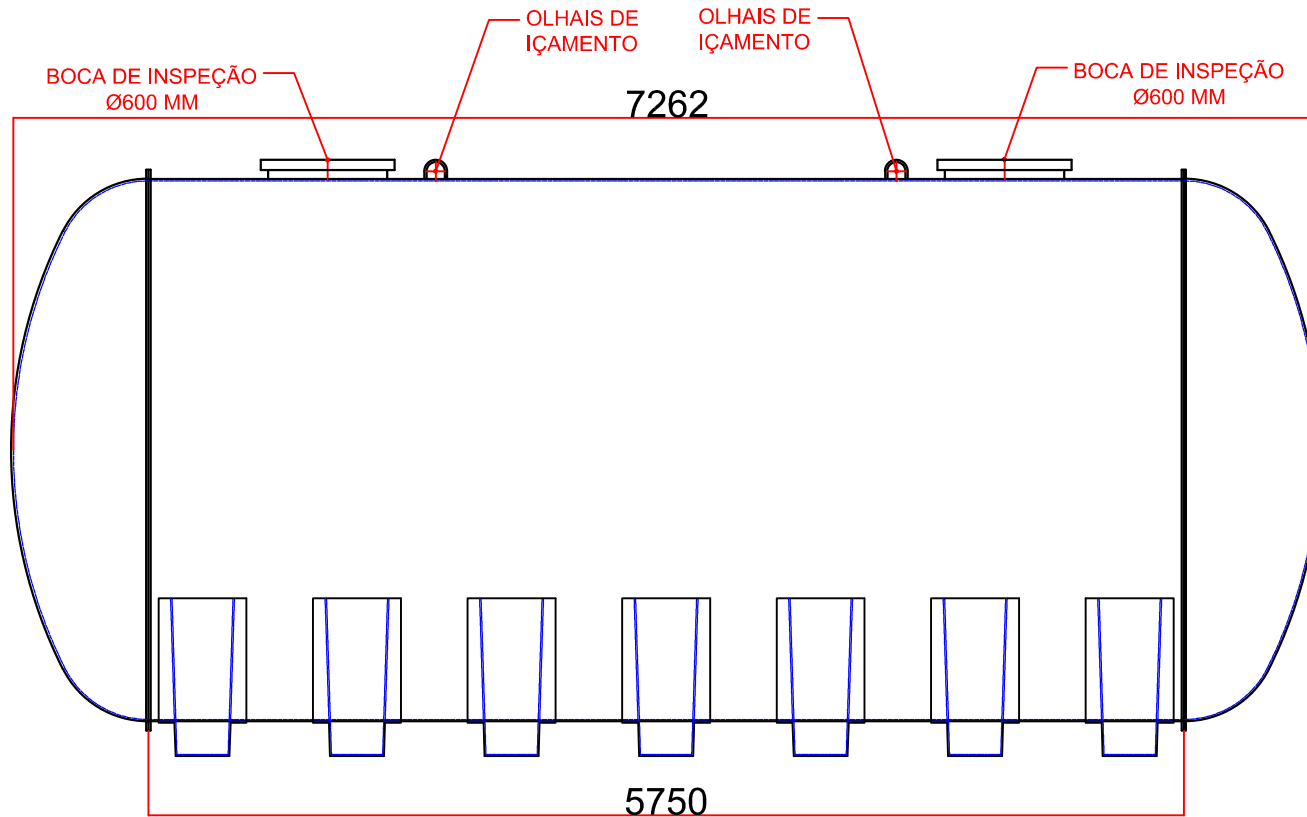

Cliente: BAKOF TEC.			 BAKOF PLÁSTICOS LTDA. BR386-Km35-Frederico Westphalen RS.	
Pedido: xxxxxxxx		Material: PRFV		
	DATA	NOME	Unid.: mm	DESCRIÇÃO: TANQUE CIL HORIZONTAL 45.000LTS
PROJ.	18/10/22	KAROLAINE S. DIAS	Quant.: 01	
DES.	18/10/22	KAROLAINE S. DIAS	Peça:	
APROV.	18/10/22	KAROLAINE S. DIAS	Escala:	